

CURSUS VOOR OPLEIDING TOT
TECHNISCH AMBTENAAR

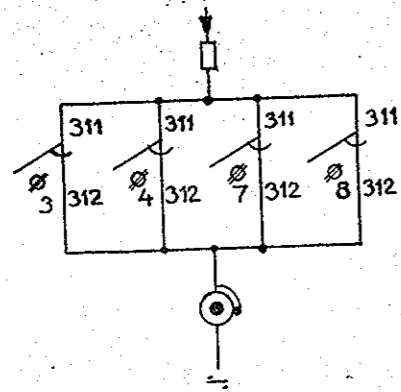

FIG. 31

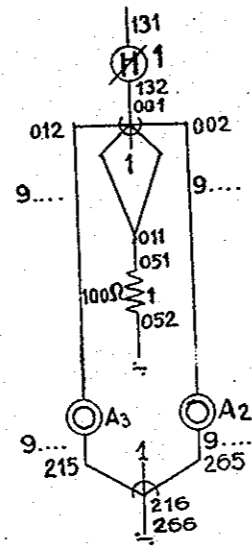

FIG. 32

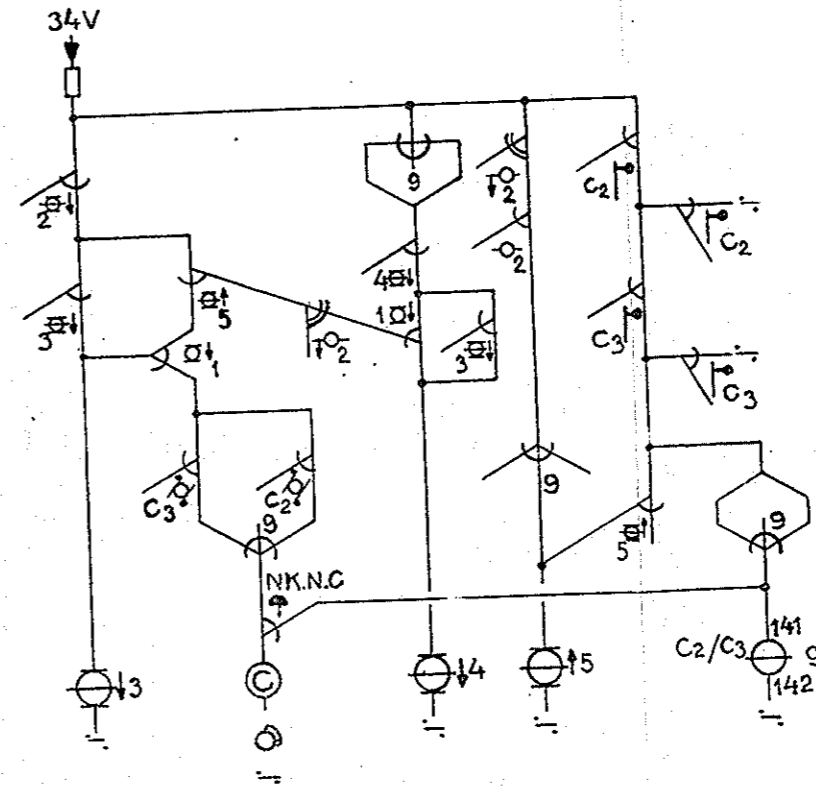
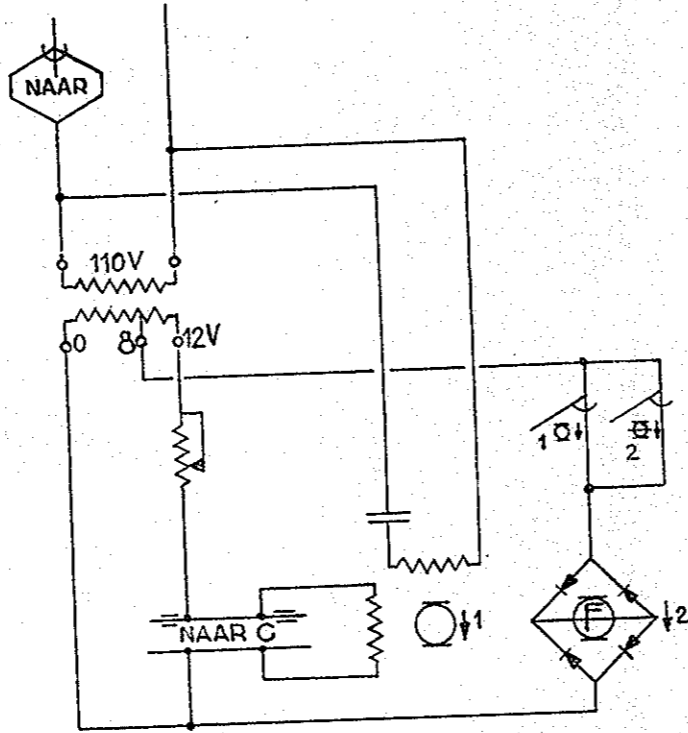
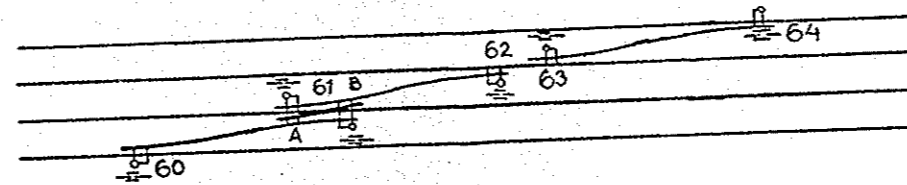
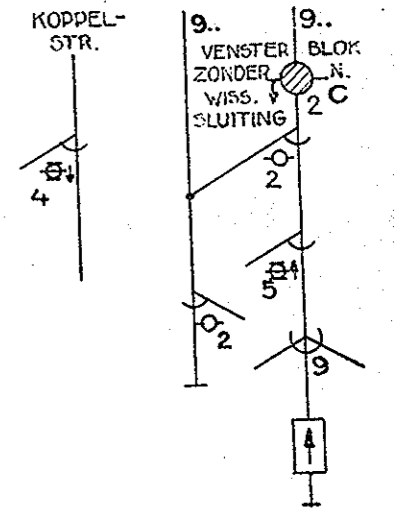

FIG. 33



SITUATIE BEHOORT BIJ FIG. 34

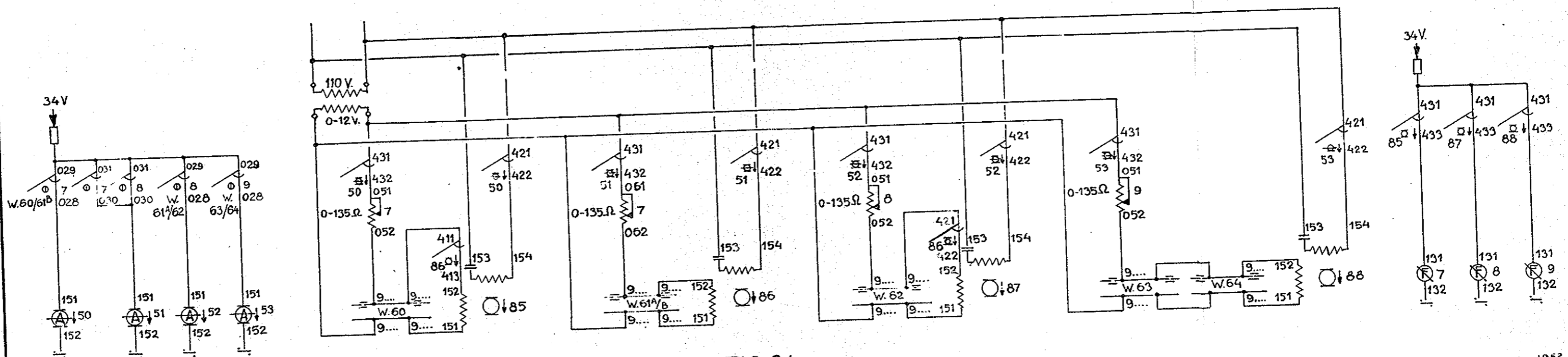

FIG. 34